

www.anicolor.pt

**SISTEMA DE
CORRER - 70 mm**

**SISTEMA
CORREDERA - 70 mm**

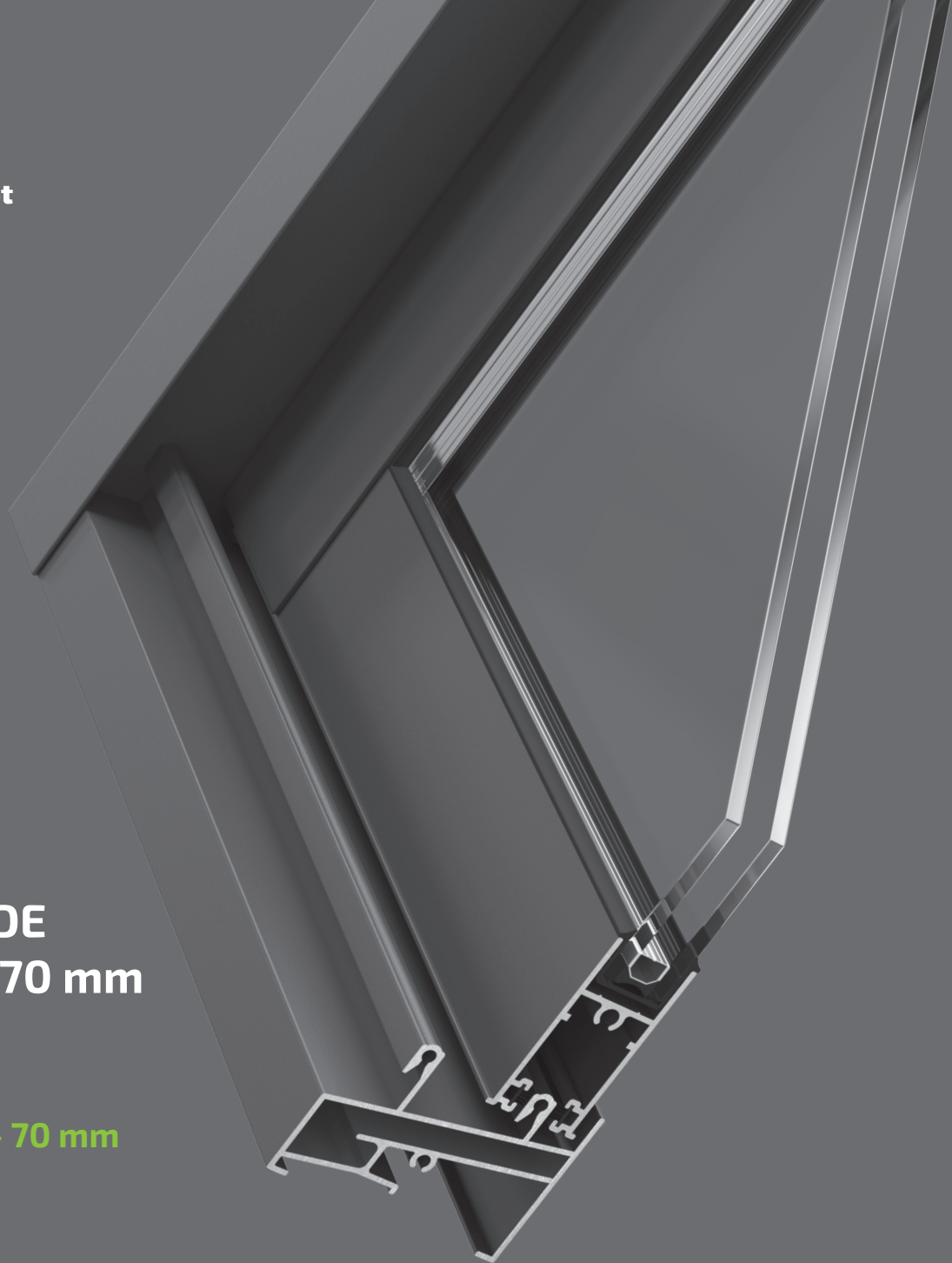

CL

SISTEMA CL

Sistema de correr - 70 mm

CARACTERÍSTICAS DOS SISTEMAS CL/CL PLUS

Sistemas de alumínio para execução de vãos de correr ou janelas duplas com rotura térmica.

PERFIS DE ALUMÍNIO

Os perfis de alumínio são extrudidos na liga de alumínio 6060 para arquitetura de acordo com norma NP EN 12020-02.

AROS FIXOS

Secção do aro fixo de 2 guias de 70 mm para montagem a corte recto;
Secção do aro fixo janela dupla de 196 mm para montagem a corte recto.

AROS MÓVEIS

Secção dos aros móveis de 28 mm com montagem a corte recto;
Enchimento de 4 mm a 18 mm;
Estanquidade assegurada através de pelúcia tipo Fin-Seal.

DIMENSIONAMENTO E MANOBRABILIDADE

Peso máximo de 80 kg por folha (com 2 rolamentos duplos);
Possibilidades de abertura: 2, 3 e 4 folhas, com folhas móveis e/ou fixas;
Rolamento duplo com regulação.

PERFORMANCES

Sistema certificado por laboratório credenciado, notificado do ensaio tipo inicial (ITT) de acordo com a norma de produto EN 14351-1 para efeitos de Marcação CE.

Categorias alcançadas na avaliação do sistema CL tipologia janela:

1. Permeabilidade ao ar: Classe 3 (norma de ensaio EN 10207 e EN 1026)
962. Estanquidade à água: Classe 7A (norma de ensaio EN 12208 e EN 1027)
3. Resistência ao vento: Classe C3 (norma de ensaio EN 12210 e EN 12211)

Categorias alcançadas na avaliação do sistema CL tipologia porta:

1. Permeabilidade ao ar: Classe 3 (norma de ensaio EN 10207 e EN 1026)
2. Estanquidade à água: Classe 7A (norma de ensaio EN 12208 e EN 1027)
3. Resistência ao vento: Classe B2 (norma de ensaio EN 12210 e EN 12211)

Coefficiente de transmissão térmica de vão de 2 folhas com 1.80 m x 2.20m com vidro Ug = 1.8 W/m²K com intercalar efeito "Warm Edge": Uw = 2.98 W/m²K

Coefficiente de atenuação acústica de vão de 2 folhas com vidro 4/10/4: Rw (C; Ctr) = 28 dB (-1; -1)

Zonas de aplicação segundo RCCTE (em função do valor Ug): I1, I2, I3, V1, V2, V3;

SISTEMA CL Plus

Categorias alcançadas na avaliação do sistema CL tipologia janela:

1. Permeabilidade ao ar: Classe 3 (norma de ensaio EN 10207 e EN 1026)
2. Estanquidade à água: Classe 4A (norma de ensaio EN 12208 e EN 1027)
3. Resistência ao vento: Classe B2 (norma de ensaio EN 12210 e EN 12211)

SISTEMA CL

Sistema corredera - 70 mm

CARACTERÍSTICAS DE LOS SISTEMAS CL/CL PLUS

Sistemas de aluminio para ejecución de huecos correderos ó ventanas dobles con rotura térmica.

PERFILES DE ALUMINIO

Los perfiles de aluminio son extrudidos en aleación de aluminio 6060 para arquitectura de acuerdo con la norma NP EN 12020-02.

MARCOS

Profundidad del marco de 2 guias de 70 mm para montaje a corte recto;
Profundidad del marco doble ventana de 196 mm para montaje a corte recto.

HOJAS

Profundidad de las hojas de 28 mm con montaje a corte recto;
Acristalamiento de 4 mm a 18 mm;
Estanquidad asegurada mediante burlete tipo Fin-Seal.

DIMENSIONAMIENTO Y MANIOBRABILIDAD

Peso máximo de 80 kg por hoja (con 2 rodamientos dobles);
Posibilidades de apertura: 2, 3 y 4 hojas, con hojas móviles y/ó fijas;
Rodamiento doble con regulación.

ENSAYOS

Sistema certificado por laboratorio credenciado, notificado para Ensayos Tipo Inicial (ITT) de acuerdo con la norma de producto EN 14351-1 para efectos de Marcado CE.

Categorias alcanzadas en el ensayo del sistema CL tipologia ventana:

1. Permeabilidad al aire: Clase 3 (norma de ensayo EN 10207 y EN 1026)
2. Estanquidad al agua: Clase 7A (norma de ensayo EN 12208 y EN 1027)
3. Resistencia al viento: Clase C3 (norma de ensayo EN 12210 y EN 12211)

Categorias alcanzadas en el ensayo del sistema CL tipologia puerta:

1. Permeabilidad al aire: Clase 3 (norma de ensayo EN 10207 y EN 1026)
2. Estanquidad al agua: Clase 7A (norma de ensayo EN 12208 y EN 1027)
3. Resistencia al viento: Clase B2 (norma de ensayo EN 12210 y EN 12211)

Coefficiente de transmisión térmica de hueco de 2 hojas con 1.80 m x 2.20m con vidrio Ug = 1.8 W/m²K con intercalar efecto "Warm Edge": Uw = 2.98 W/m²K

Coefficiente de atenuación acústica de hueco de 2 hojas con vidrio 4/10/4: Rw (C; Ctr) = 28 dB (-1; -1)

SISTEMA CL Plus

Categorias alcanzadas en el ensayo del sistema CL tipologia ventana:

1. Permeabilidad al aire: Clase 3 (norma de ensayo EN 10207 y EN 1026)
2. Estanquidad al agua: Clase 4A (norma de ensayo EN 12208 y EN 1027)
3. Resistencia al viento: Clase B2 (norma de ensayo EN 12210 y EN 12211)

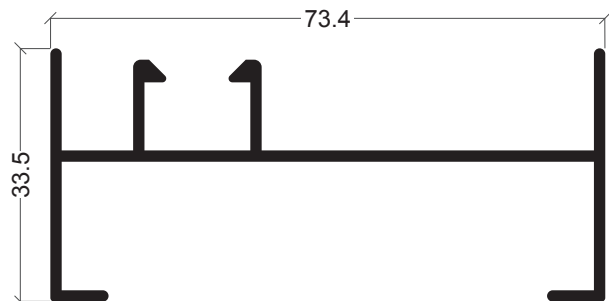

CL-06
Ombreira
Marco lateral

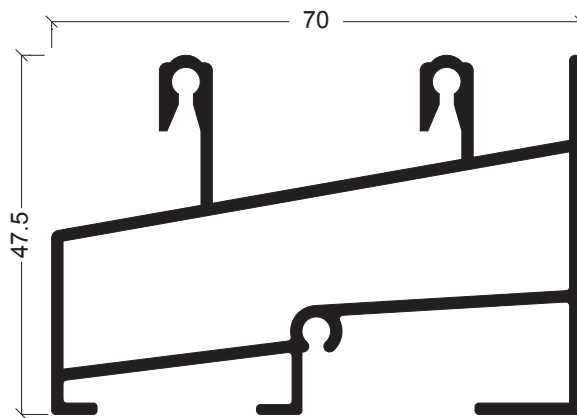

CL-03
Soleira
Marco interior

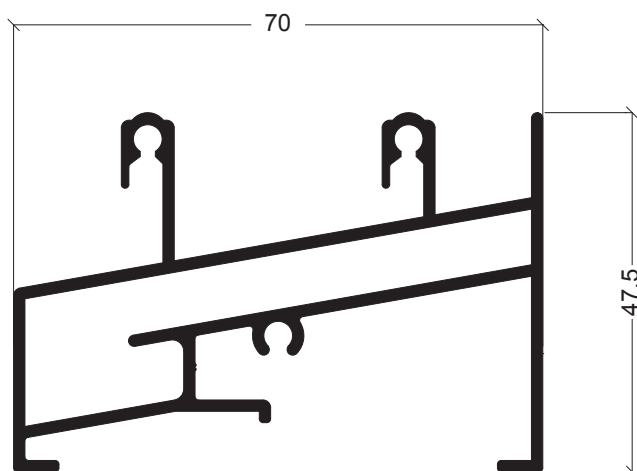

CL-01
Soleira
Marco interior

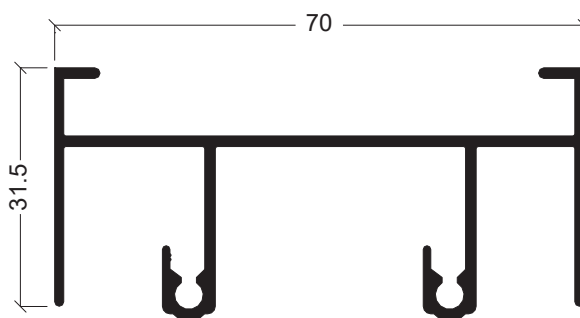

CL-05
Padeira
Marco superior

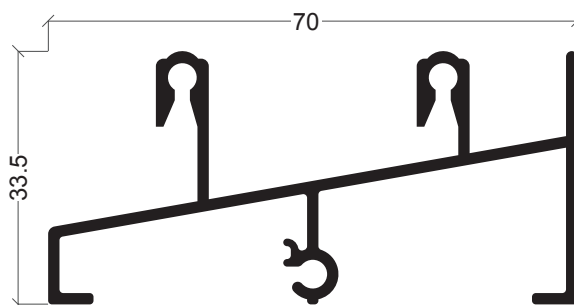

CL-61
Soleira
Marco interior

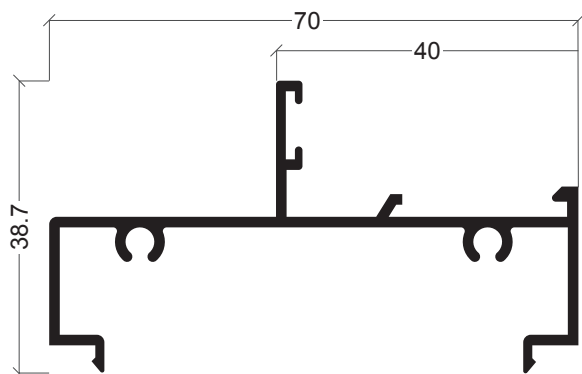

CL-18
Complemento fixo
Mainel

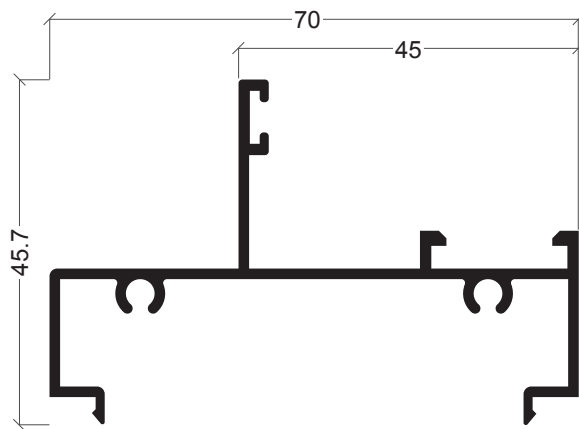

CL-08
Complemento fixo
Mainel

98

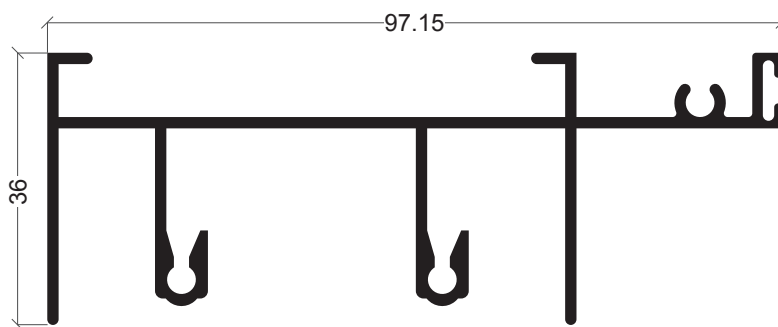

CL-15
Padeira
Marco superior con marco para guia

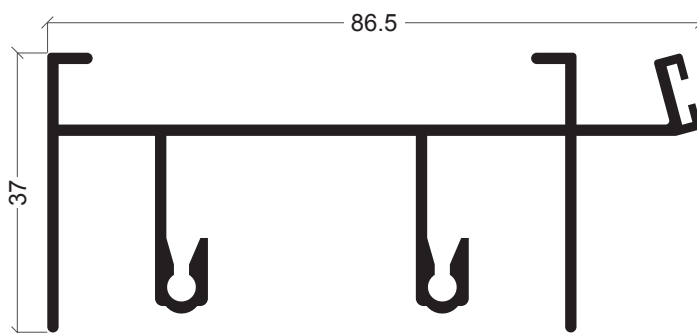

CL-75
Padeira janela dupla
Marco superior doble corredera

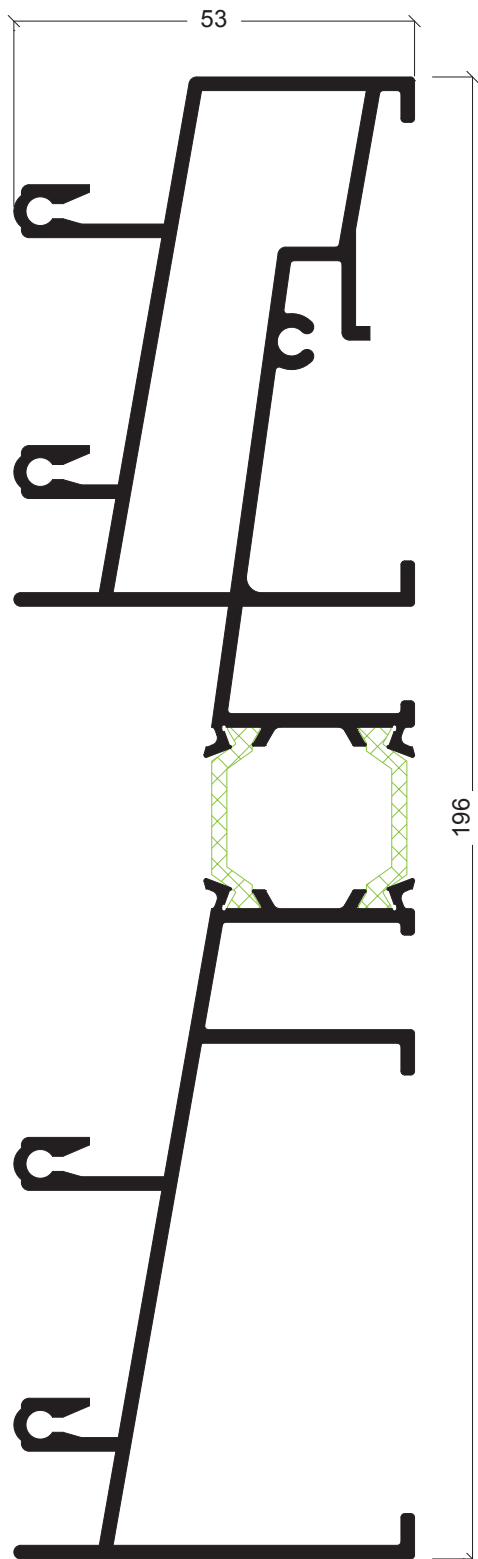

CL-71

Soleira janela dupla
Marco inferior doble corredera

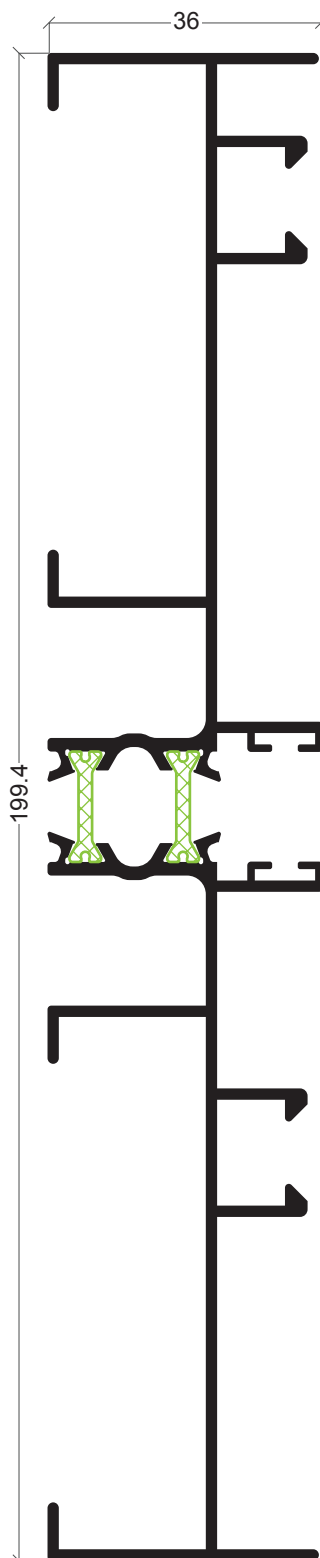

CL-76

Ombreira janela dupla
Marco lateral doble corredera

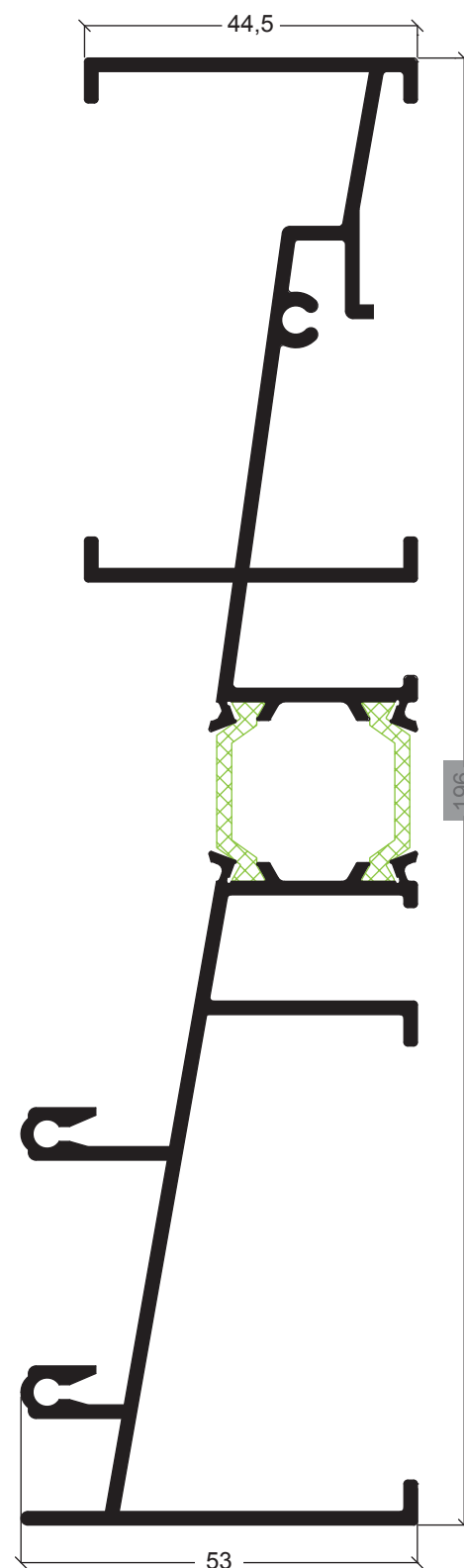

CL-78

Soleira janela dupla
Marco inferior con fijo exterior

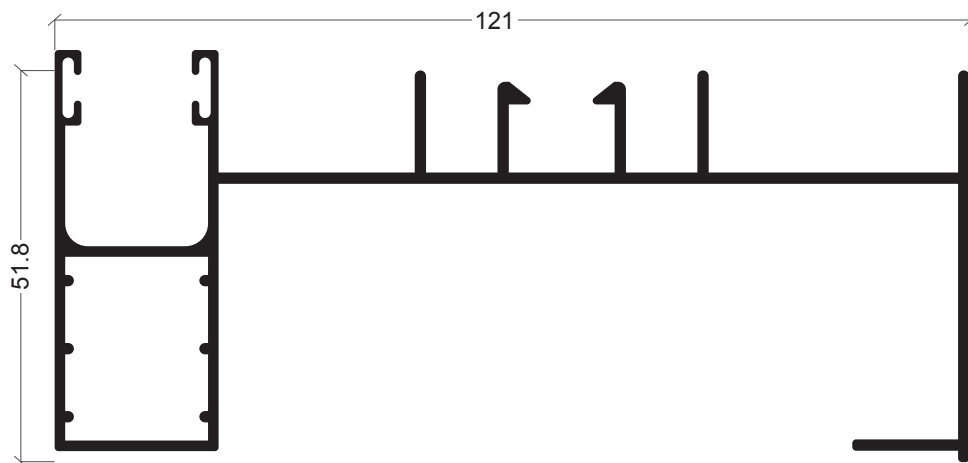

CL-91

Ombreira com calha persiana
Marco lateral integral

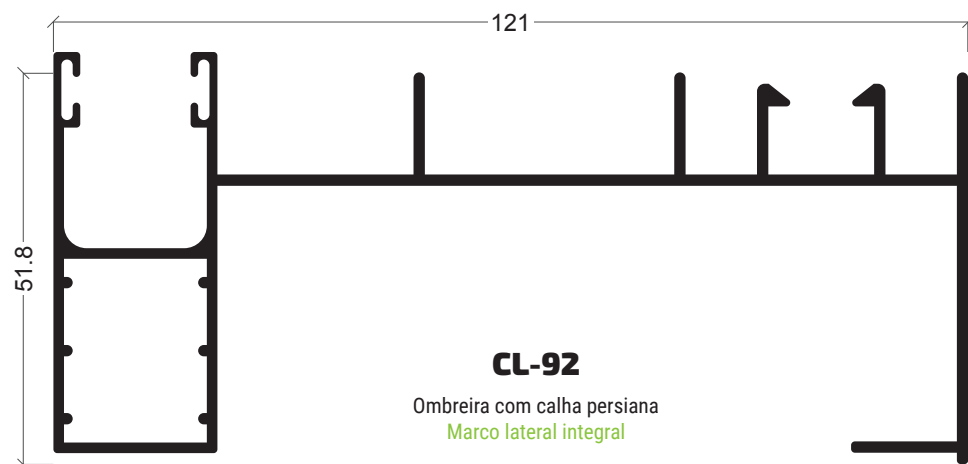

CL-92

Ombreira com calha persiana
Marco lateral integral

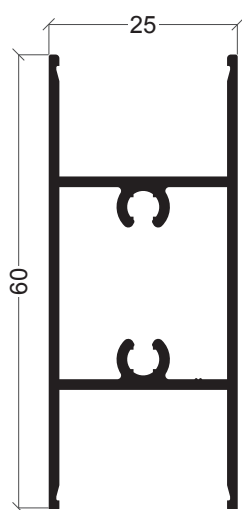

CL-53

Travessa
Divisor vidro

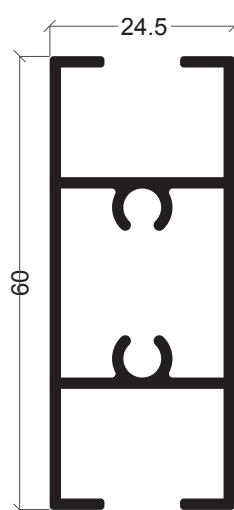

CL-73

Travessa
Divisor vidro

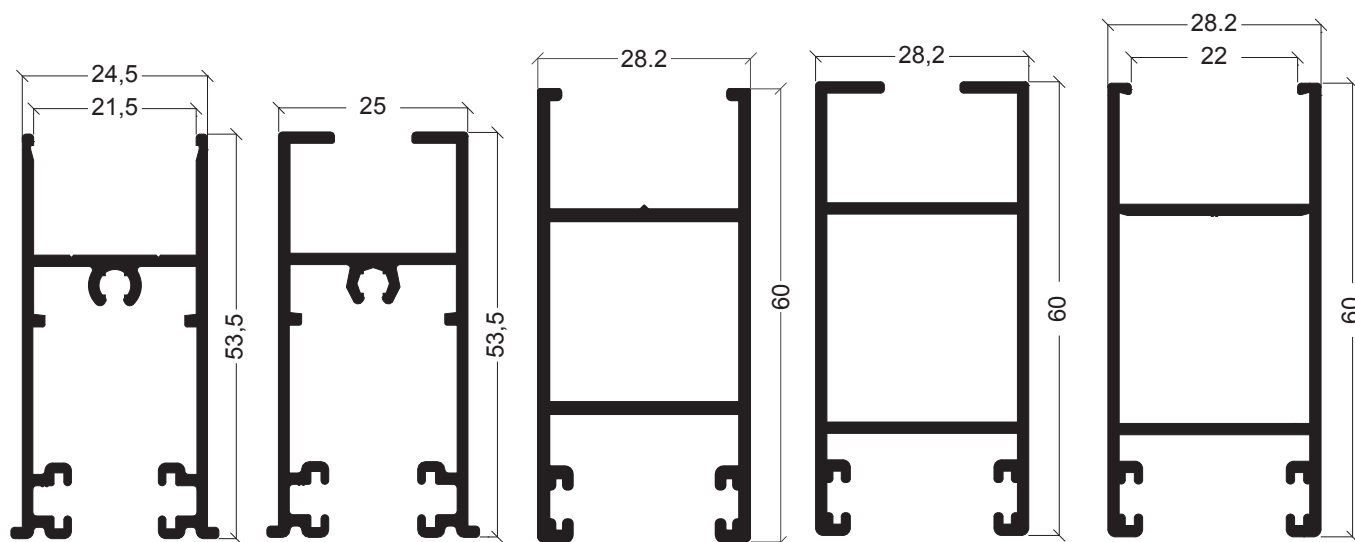

CL-10

Móvel carrinho
Hoja de ruedas

CL-12

Móvel Carrinho
Hoja de ruedas

CL-90

Móvel lateral
Hoja lateral

CL-19

Móvel lateral
Hoja lateral

CL-20

Móvel lateral
Hoja lateral

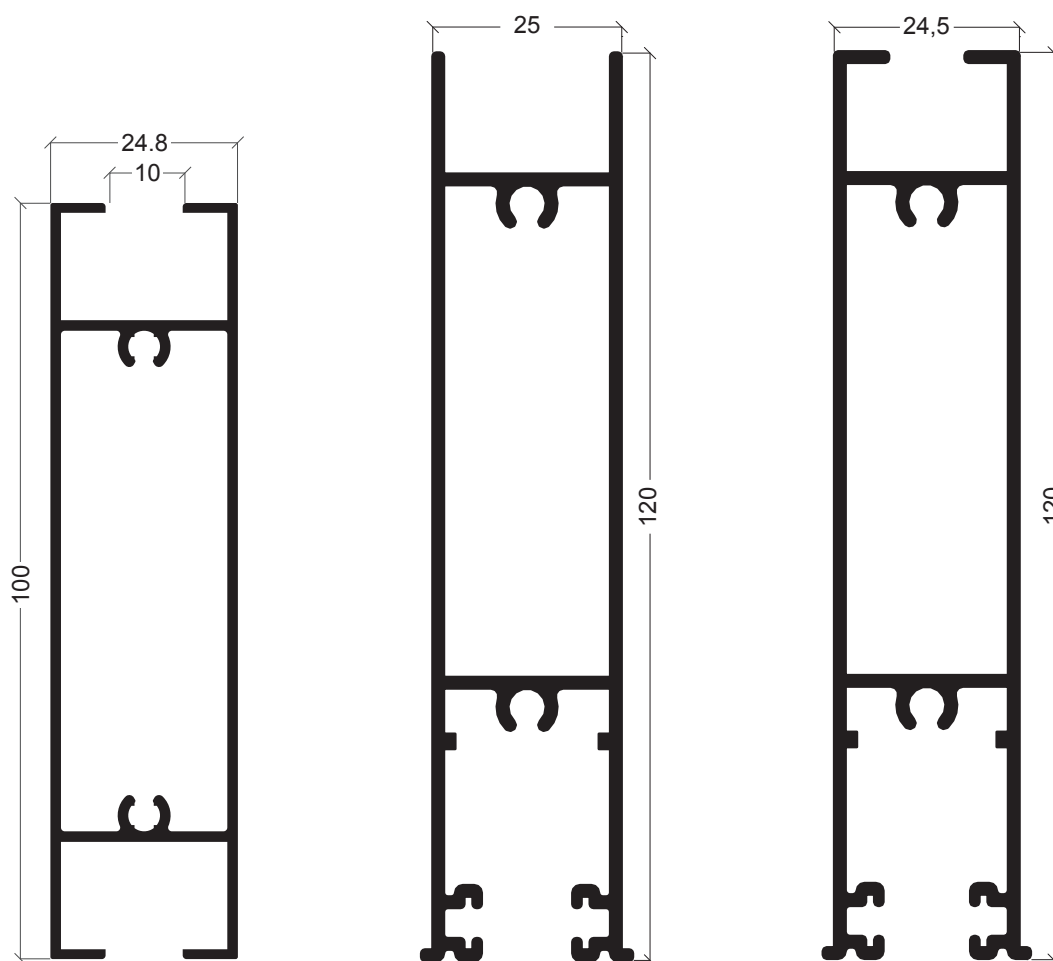

CL-25

Travessa
Travesaño

CL-52

Almofada carrinho
Zócalo 120mm

CL-72

Almofada carrinho
Zócalo 120mm

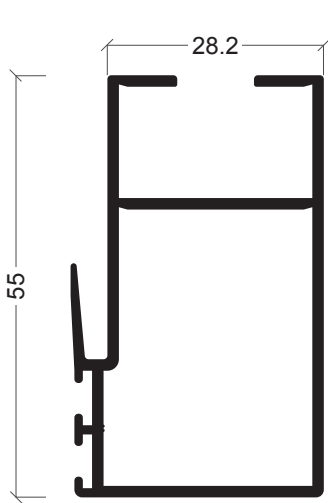

CL-17
Móvel central
Hoja central

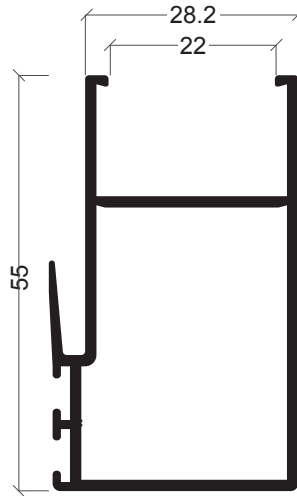

CL-09
Móvel central
Hoja central

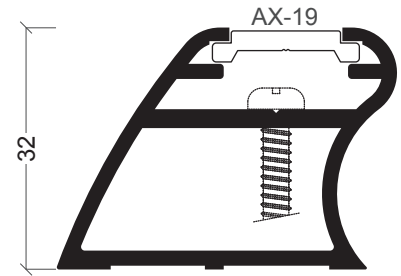

CT-27
Reforço
Refuerzo hoja

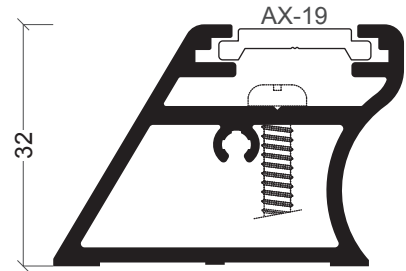

CT-28
Reforço
Refuerzo hoja

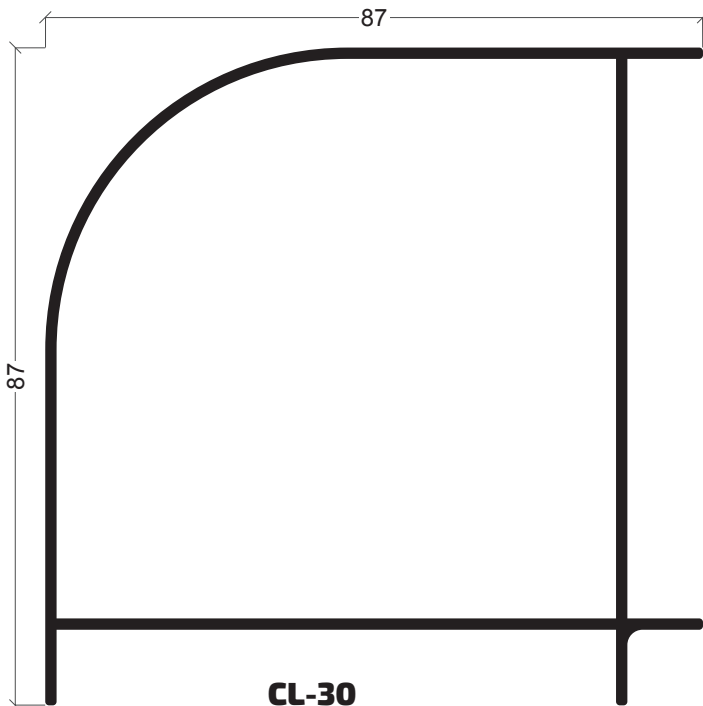

CL-30
Esquina
Esquinero 90°

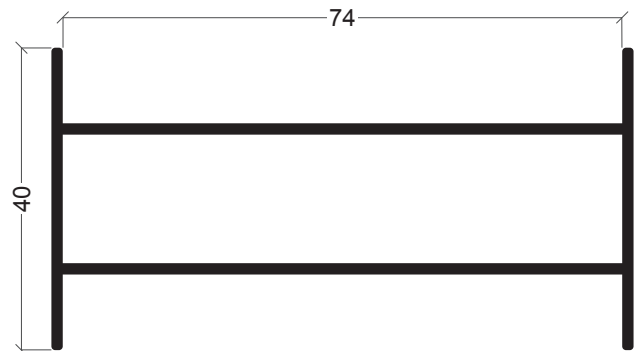

CL-32
União de aros
Unión de marcos

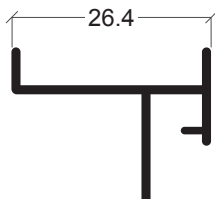

CL-57
Remate persiana
Complemento registro



Y-24
Remate p/ apanelado
Solape p/ precerco



AX-19
Vareta
Pletina falleba

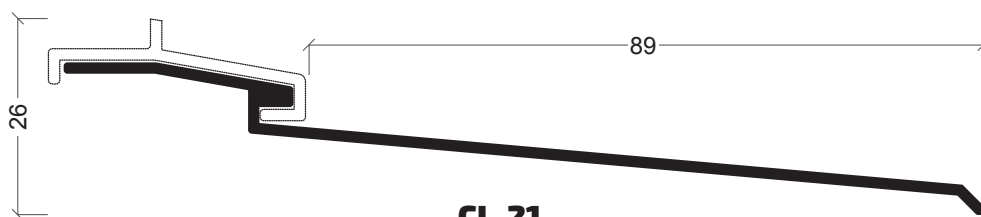
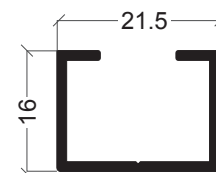
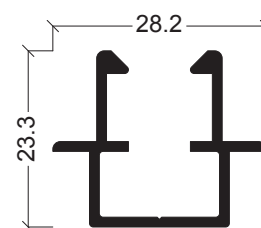
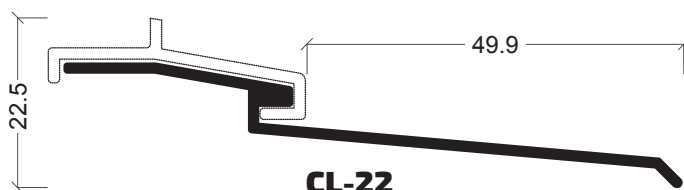
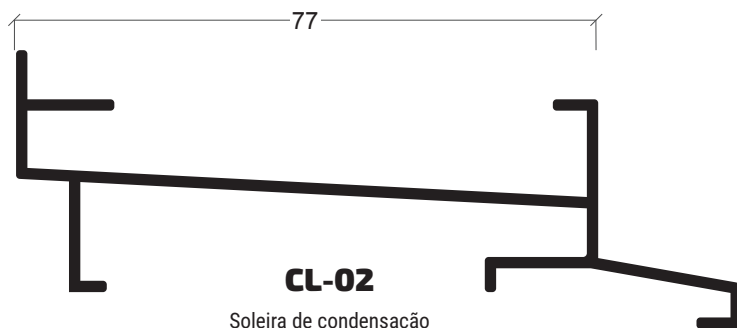

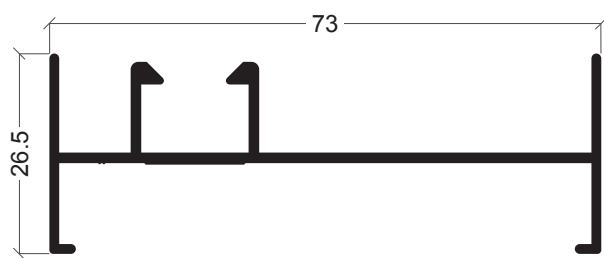

CL-43
Ombreira
Marco lateral

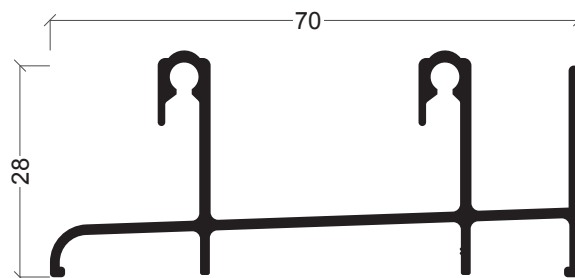

CL-42
Soleira
Marco inferior

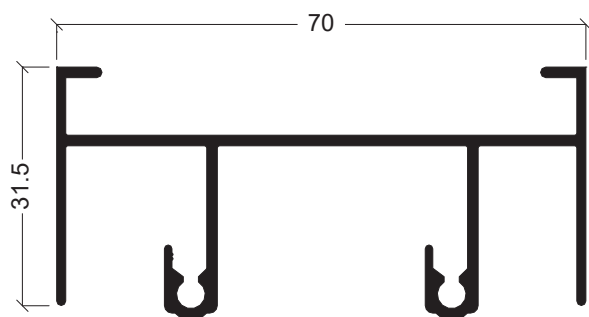

CL-05
Padeira
Marco Superior

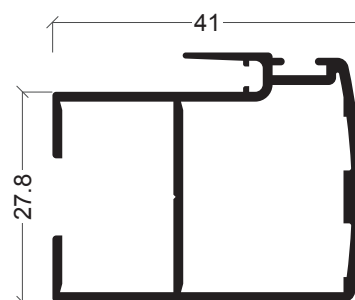

CL-33
Móvel central janela
Hoja central ventana

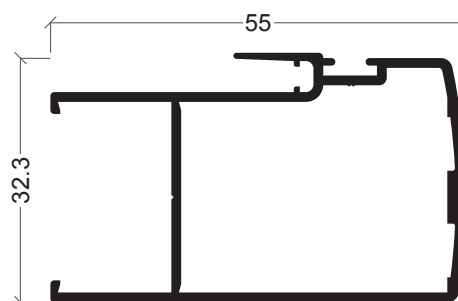

CL-48
Móvel central porta
Marco central puerta

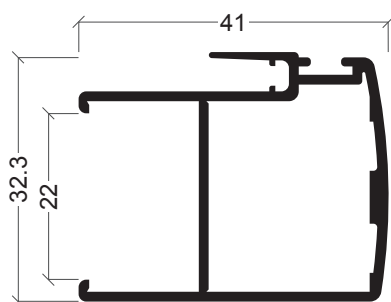

CL-45
Móvel central janela
Hoja central ventana

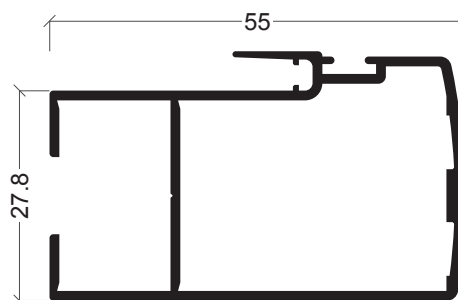

CL-59
Móvel central porta
Hoja central puerta

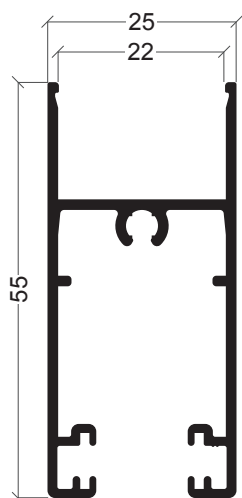

CL-47

Móvel carrinho
Hoja de ruedas

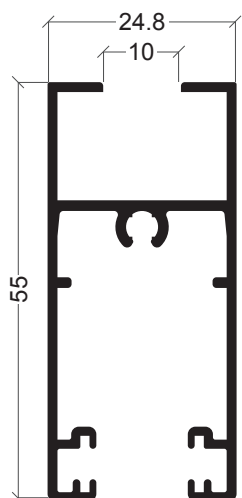

CL-40

Móvel carrinho
Hoja de ruedas

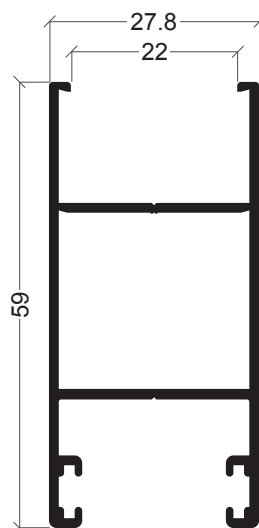

CL-44

Móvel lateral
Hoja lateral

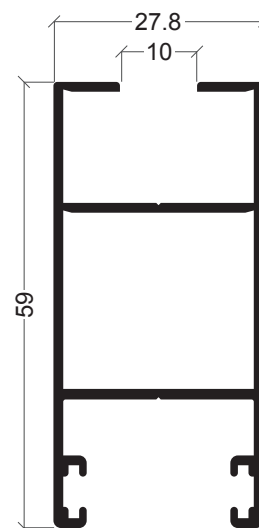

CL-34

Móvel lateral
Hoja lateral

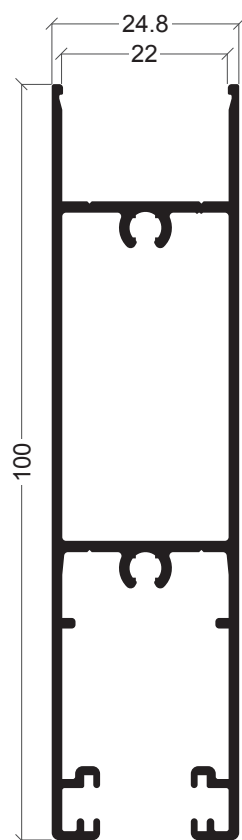

CL-49

Almofada
Zócalo 100mm

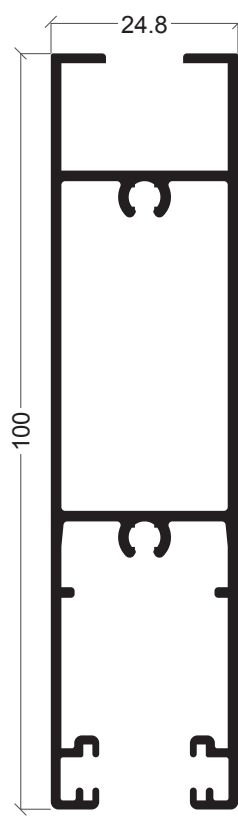

CL-24

Almofada
Zócalo 100mm

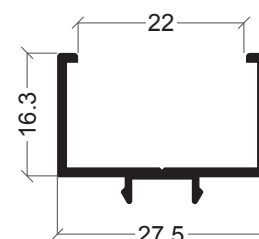

CL-50

Redutor
Adaptador

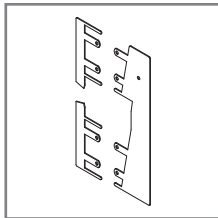

30 20 50 01

Jogo juntas estanquidade janela dupla
Juego juntas estanquidad doble ventana

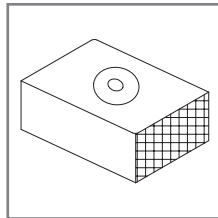

30 91 41 10

Taco anti-levantamento preto
Taco antilevantamiento negro



30 91 41 31

Barra 2 pontos com apoios (600mm)
Barra 2 puntos con apoios (600 mm)

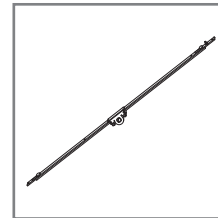

30 91 41 32

Barra 3 pontos com apoios (600mm)
Barra 3 puntos con apoios (1670 mm)

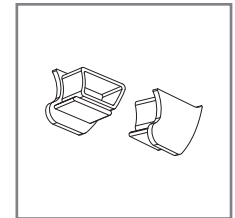

30 91 41 35

Jogo topos CT-3
Juego topos CT-3

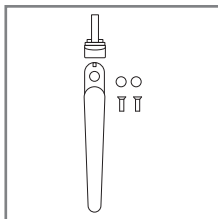

30 91 41 45

Puxador baixo Branco
Manilla bajo Blanco

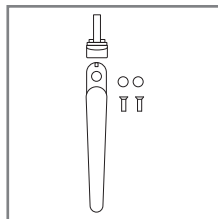

30 91 41 46

Puxador baixo Preto
Manilla bajo Negro

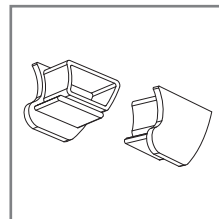

30 91 41 63

Jogo topos CT-27 (branco)
Juego topos CT-27 (blanco)

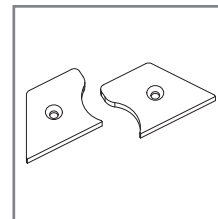

30 91 41 65/66

Jogo topos CT-28 (branco/preto)
Juego topos CT-28 (blanco/negro)

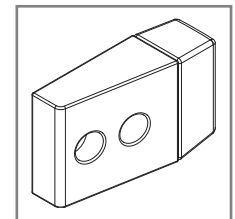

30 91 41 71

Topo limitador de abertura
Tope limitador de apertura

106

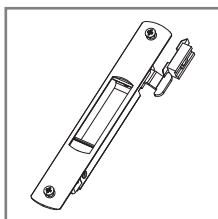

30 91 50 09/10

Fecho lateral (branco/preto)
Cierre lateral (blanco/negro)

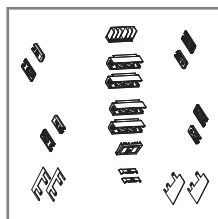

30 91 50 11

Kit CL 2 folhas
Kit CL 2 hojas

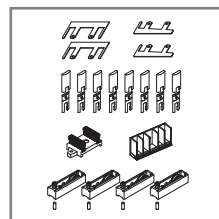

30 91 50 15

Kit correr janela 2 folhas CL-42
Kit corredera ventana 2 hojas CL-42

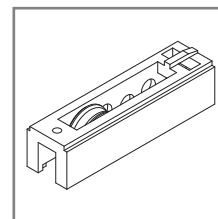

30 91 50 20

Rolamento simples CL-10/12/52/72
Rodamiento simples CL-10/12/52/72

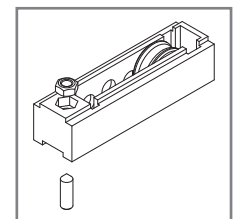

30 91 50 21

Rolamento simples CL Plus (40Kg por folha)
Rodamiento simples CL Plus (40Kg por hoja)

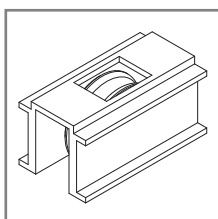

30 91 50 22

Rolamento simples CL-10/12/52/72
Rodamiento simples CL-10/12/52/72

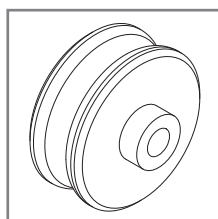

30 91 50 23

Rolamento suplementar (+20Kg por folha)
Rodamiento suplementario (+20Kg por hoja)

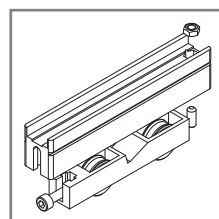

30 91 50 24

Rolamento duplo CL Plus regulável
(80Kg por folha)
Rodamiento doble CL Plus regulable
(80Kg por hoja)

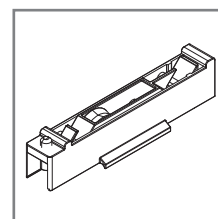

30 91 50 25

Rolamentos duplo CL
Rodamiento doble CL

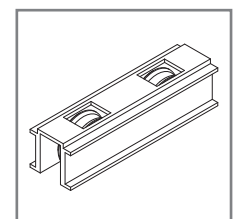

30 91 50 27

Rolamento duplo CL-10/12/52/72
Rodamiento doble CL-10/12/52/72

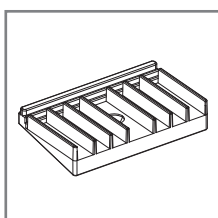

30 91 50 30

Corta-vento inferior CL
Cortaviento inferior CL

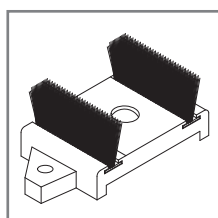

30 91 50 31

Corta-vento inferior CL-42
Cortavientos inferior CL-42

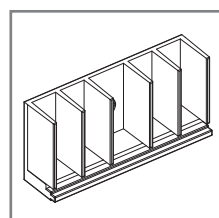

30 91 50 40

Corta-vento superior CL-05/15/75
Cortaviento superior CL-05/15/75

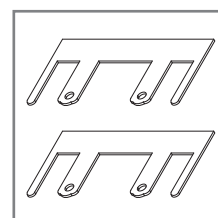

30 91 50 61

Junta estanquidade superior CL-05
Junta estanquidad superior CL-05

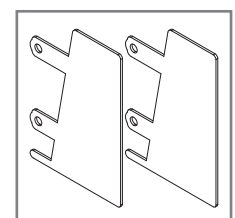

30 91 50 70

Junta estanquidade CL-01/03/63/61
Junta estanquidad CL-01/03/63/61

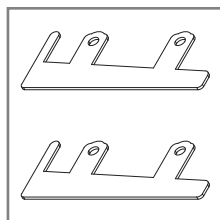

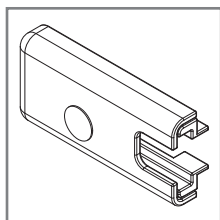
30 91 50 71

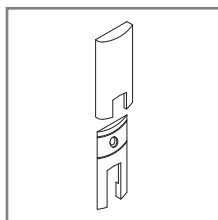
 Junta estanquidade inferior CL-42
 Junta estanqueidad inferior CL-42

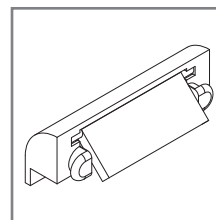
30 91 50 80

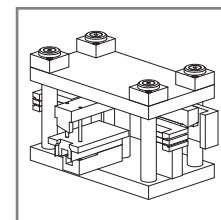
 Tampa guia lateral CL
 Topé guia lateral CL

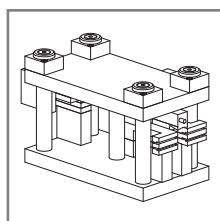
30 91 50 81

 Jogo guias lateral CL Plus
 Juego topes laterales CL Plus

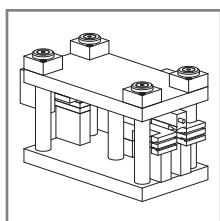
30 92 01 02/03

 Goteiras preto/branco
 Tapa salida de aguas con deflector negro / blanco

33 21 50 01

 Cunho CL dupla
 Troquel CL dupla

33 24 50 01















 Cunho CL Plus
 Troquel CL Plus

33 95 99 99

 Cunho CL
 Troquel CL

REFERÊNCIA • REFERENCIA	DESENHO • DISEÑO	DESCRIÇÃO • DESCRIPCIÓN
30 91 50 86		Junta central • Junta central
30 91 50 90		Junta U CL/CL Plus vidro 18mm • Junta U CL/CL Plus vidrio 18mm
30 93 00 65		Junta interior para vidro (5 mm) • Junta interior para vidrio (5 mm)
30 93 00 66		Junta interior para vidro (4 mm) • Junta interior para vidrio (4 mm)
30 93 00 67		Junta interior para vidro (2 mm) • Junta interior para vidrio (2 mm)
30 93 00 68		Junta interior para vidro (6/7 mm) • Junta interior para vidrio (6/7 mm)
30 93 00 69		Junta interior para vidro (8/9 mm) • Junta interior para vidrio (8/9 mm)
30 95 00 40		Pelúcia 7x5.5 mm • Burlete 7x5.5 mm
30 95 00 70		Pelúcia 7x3.5 mm • Burlete 7x3.5 mm
30 95 00 80		Pelúcia 7x5 mm • Burlete 7x5 mm

Janela 2 folhas correr • Ventana 2 hojas corredera

PERFIS • PERFIS

DESENHO • DISEÑO	REF.	DESCRIÇÃO • DESCRIPCIÓN	CORTE CORTE	QUANTIDADE CANTIDAD	MEDIDAS • MEDIDA
	CL-05	Padieira • Marco superior		1	L-40 mm
	CL-01	Soleira • Marco inferior		1	L-40 mm
	CL-06	Ombreira • Marco lateral		2	H
	CL-10	Móvel carrinho • Hoja de ruedas		4	L/2-12 mm
	CL-20	Móvel lateral • Hoja lateral		2	H-64 mm
	CL-09	Móvel central • Hoja central		2	H-64 mm
	CL-22	Pingadeira • Alargadera 50mm		1	L

ACESSÓRIOS E JUNTAS • ACCESORIOS Y JUNTAS







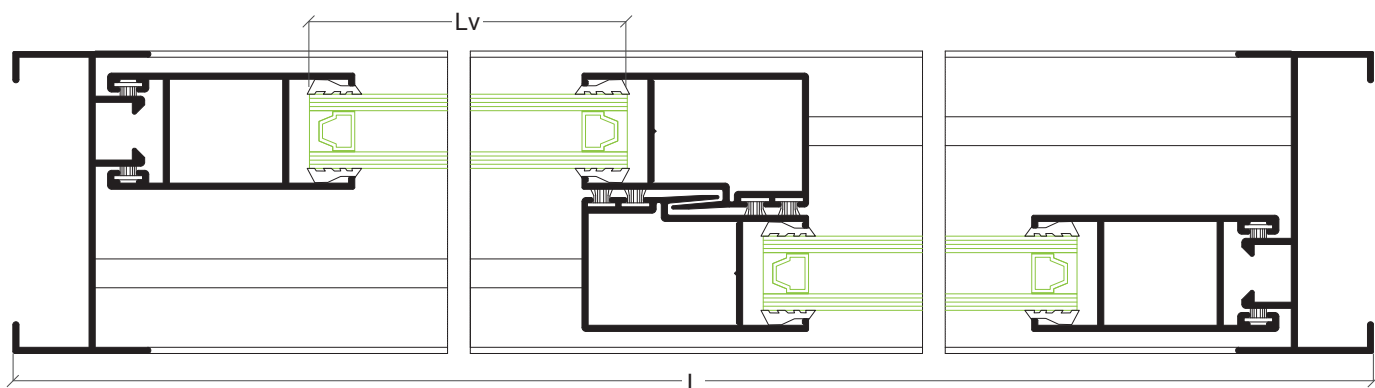
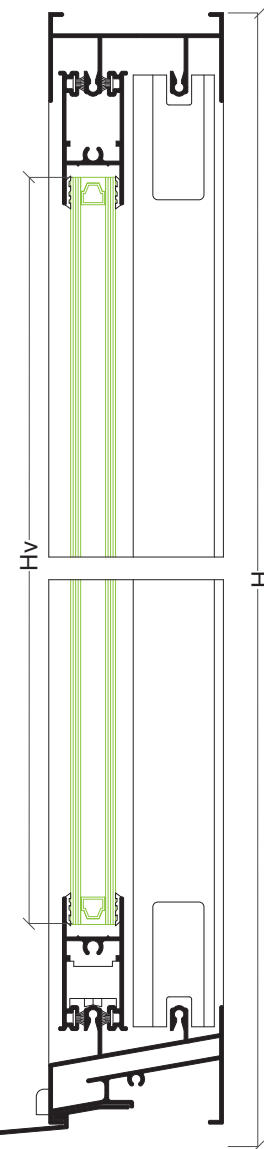
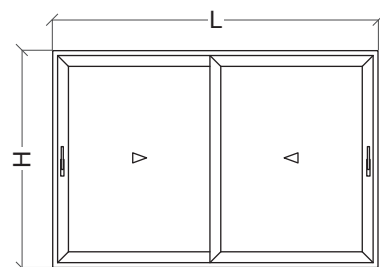

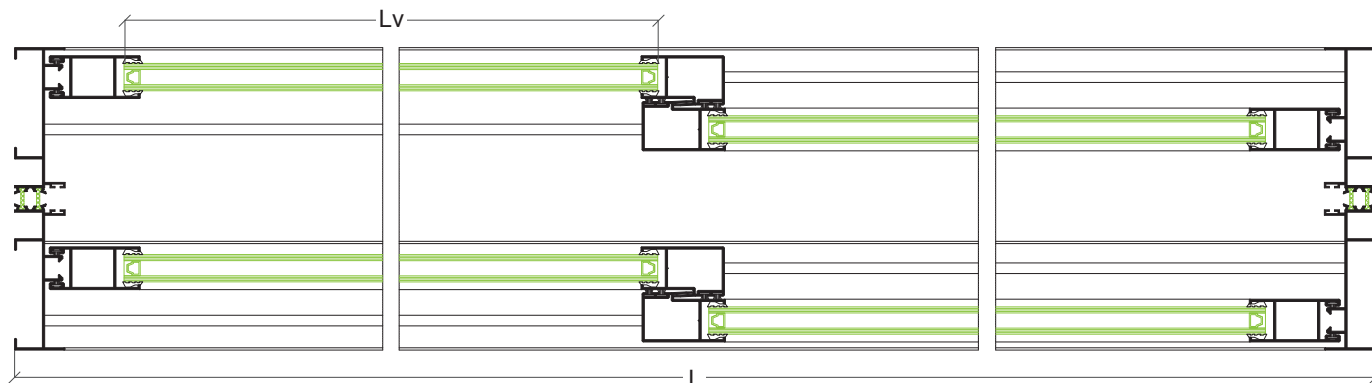
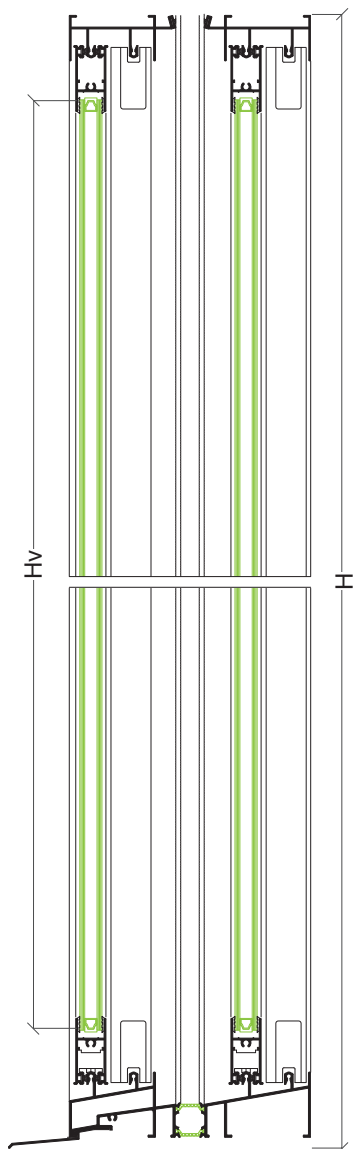
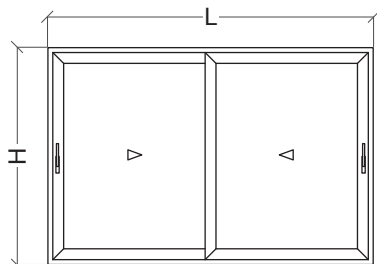

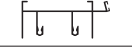

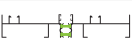

REF.	DESCRIÇÃO • DESCRIPTION	QUANTIDADE CANTIDAD
30 91 50 09/10	Fecho lateral • Cierre lateral	2
30 91 50 22	Rolamentos • Rodamientos	4
30 91 50 30	Corta ventos inferior • Cortavientos inferior	1
30 91 50 40	Corta ventos superior • Cortavientos superior	1
30 91 50 61	Junta estanquidade superior • Junta estanqueidad superior	1
30 91 50 70	Junta estanquidade inferior • Junta estanqueidad inferior	1
30 91 50 80	Tampa guia lateral • Tapón guía lateral	4
30 92 01 00	Goteiras • Vierendeaguas	2
30 95 00 40	Pelúcia 7x5.5 mm • Burlete 7x5.5 mm	8L/2
30 95 00 70	Pelúcia 7x3.5 mm (lateral) • Burlete 7x3.5 mm (lateral)	4H
30 95 00 80	Pelúcia 7x5 mm (central) • Burlete 7x5 mm (central)	4H
---	Junta para vidro • Junta para vidrio	4L+8H

VIDRO • VIDRIO

Hv = H-146 mm	Lv = L/2-89 mm
---------------	----------------



Janela 2 folhas dupla correr • Ventana 2 hojas dupla corredera

PERFIS • PERFIS

DESENHO • DISEÑO	REF.	DESCRIÇÃO • DESCRIPCIÓN	CORTE CORTE	QUANTIDADE CANTIDAD	MEDIDAS • MEDIDA
	CL-75	Padieira • Marco superior		2	L-46 mm
	CL-71	Soleira • Marco inferior		1	L-46 mm
	CL-76	Ombreira • Marco lateral		2	H
	CL-10	Móvel carrinho • Hoja de ruedas		8	L/2-15 mm
	CL-20	Móvel lateral • Hoja lateral		4	H-71 mm
	CL-09	Móvel central • Hoja central		4	H-71 mm
	CL-22	Pingadeira • Alargadera 50mm		1	L

ACESSÓRIOS E JUNTAS • ACCESORIOS Y JUNTAS











REF.	DESCRIÇÃO • DESCRIPTION	QUANTIDADE CANTIDAD
30 20 50 01	Jogo juntas estanquidade janela dupla • Juego juntas estanqueidad doble ventana	1
30 91 50 09/10	Fecho lateral • Cierre lateral	4
30 91 50 22	Rolamentos • Rodamientos	8
30 91 50 30	Corta ventos inferior • Cortavientos inferior	2
30 91 50 40	Corta ventos superior • Cortavientos superior	2
30 91 50 80	Tampa guia lateral • Tapa guia lateral	8
30 91 50 85	Guia de persiana • Guia de persiana	2
30 92 01 00	Goteiras • Vierendeaguas	2
30 95 00 40	Pelúcia 7x5.5 mm • Burlete 7x5.5 mm	16L/2 2L
30 95 00 70	Pelúcia 7x3.5 mm (lateral) • Burlete 7x3.5 mm (lateral)	8H
30 95 00 80	Pelúcia 7x5 mm (central) • Burlete 7x5 mm (central)	8H
---	Junta para vidro • Junta para vidrio	8L+16H

VIDRO • VIDRIO

Hv = H-153 mm	Lv = L/2-92 mm
---------------	----------------

Janela 3 folhas correr • Ventana 3 hojas corredera

PERFIS • PERFIS

DESENHO • DISEÑO	REF.	DESCRIÇÃO • DESCRIPCIÓN	CORTE CORTE	QUANTIDADE CANTIDAD	MEDIDAS • MEDIDA
	CL-05	Padieira • Marco superior		1	L-40 mm
	CL-01	Soleira • Marco inferior		1	L-40 mm
	CL-06	Ombreira • Marco lateral		2	H
	CL-10	Móvel carrinho • Hoja de ruedas		4	L/3+7 mm
				2	L/3+15 mm
	CL-20	Móvel lateral • Hoja lateral		2	H-64 mm
	CL-09	Móvel central • Hoja central		4	H-64 mm
	CL-22	Pingadeira • Alargadera 50mm		1	L

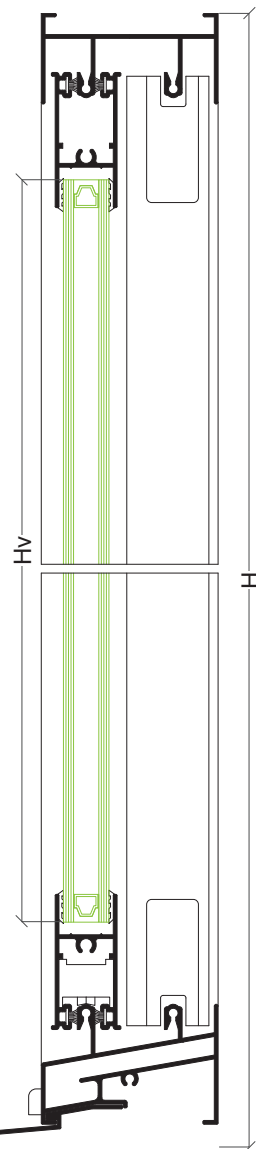
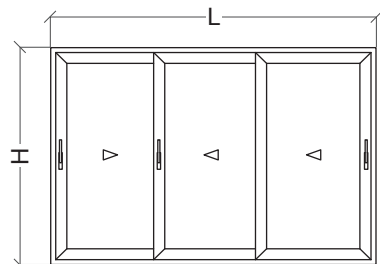

ACESSÓRIOS E JUNTAS • ACCESORIOS Y JUNTAS







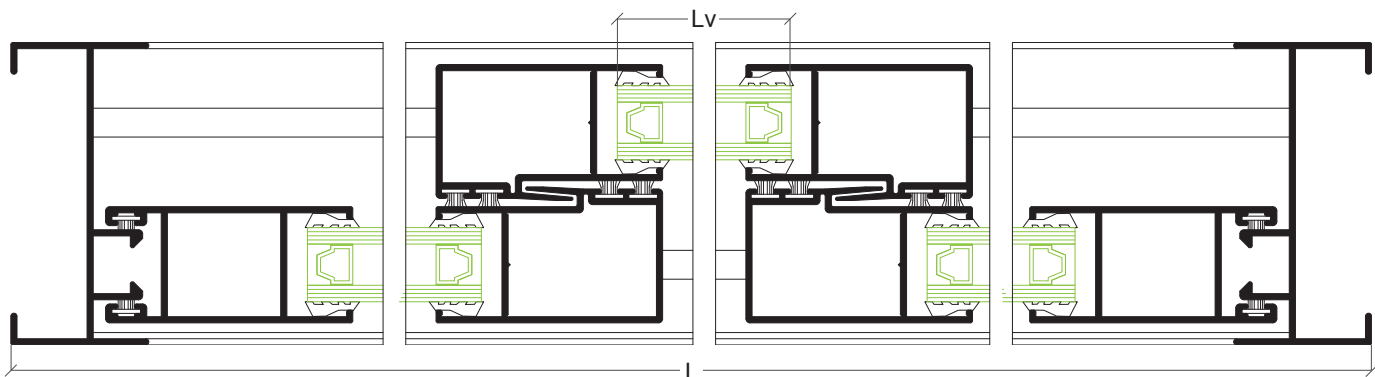

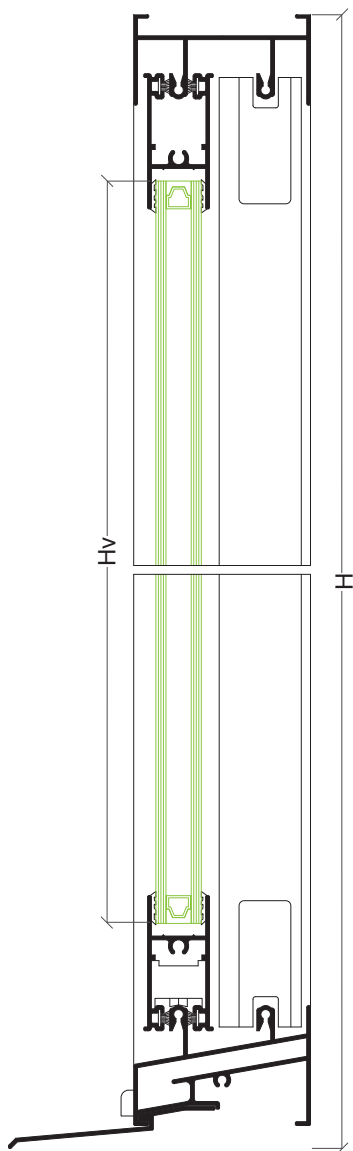
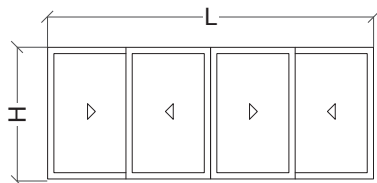







REF.	DESCRIÇÃO • DESCRIPTION	QUANTIDADE CANTIDAD
30 91 50 09/10	Fecho lateral • Cierre lateral	2
30 91 50 22	Rolamentos • Rodamientos	6
30 91 50 30	Corta ventos inferior • Cortavientos inferior	2
30 91 50 40	Corta ventos superior • Cortavientos superior	2
30 91 50 61	Junta estanquidade superior • Junta estanqueidad superior	1
30 91 50 70	Junta estanquidade inferior • Junta estanqueidad inferior	1
30 91 50 80	Tampa guia lateral • Tope guia lateral	8
30 92 01 00	Goteiras • Vierteaguas	2
30 95 00 40	Pelúcia 7x5.5 mm • Burlete 7x5.5 mm	12L/3
30 95 00 70	Pelúcia 7x3.5 mm (lateral) • Burlete 7x3.5 mm (lateral)	4H
30 95 00 80	Pelúcia 7x5 mm (central) • Burlete 7x5 mm (central)	4H
---	Junta para vidro • Junta para vidrio	4L+12H

VIDRO • VIDRIO

Hv = H-146 mm	Lv = L/3-70 mm
---------------	----------------



Janela 4 folhas correr • Ventana 4 hojas corredera

PERFIS • PERFIS

DESENHO • DESEÑO	REF.	DESCRIÇÃO • DESCRIPCIÓN	CORTE CORTE	QUANTIDADE CANTIDAD	MEDIDAS • MEDIDA
	CL-05	Padieira • Marco superior		1	L-40 mm
	CL-01	Soleira • Marco inferior		1	L-40 mm
	CL-06	Ombreira • Marco lateral		2	H
	CL-10	Móvel carrinho • Hoja de ruedas		8	L/4-2 mm
	CL-20	Móvel lateral • Hoja lateral		4	H-64 mm
	CL-09	Móvel central • Hoja central		4	H-64 mm
	CL-28	União de 4 folhas • Unión de 4 hojas		1	H-64 mm
	CL-22	Pingadeira • Alargadera 50mm		1	L

ACESSÓRIOS E JUNTAS • ACCESORIOS Y JUNTAS

REF.	DESCRIÇÃO • DESCRIPTION	QUANTIDADE CANTIDAD
30 91 50 09/10	Fecho lateral • Cierre lateral	3
30 91 50 22	Rolamentos • Rodamientos	8
30 91 50 30	Corta ventos inferior • Cortavientos inferior	3
30 91 50 40	Corta ventos superior • Cortavientos superior	3
30 91 50 61	Junta estanquidade superior • Junta estanqueidad superior	1
30 91 50 70	Junta estanquidade inferior • Junta estanqueidad inferior	1
30 91 50 80	Tampa guia lateral • Tope guia lateral	8
30 92 01 00	Goteiras • Goteo	3
30 95 00 40	Pelúcia 7x5.5 mm • Burlete 7x5.5 mm	16L/4
30 95 00 70	Pelúcia 7x3.5 mm (lateral) • Burlete 7x3.5 mm (lateral)	6H
30 95 00 80	Pelúcia 7x5 mm (central) • Burlete 7x5 mm (central)	8H
---	Junta para vidro • Junta para vidrio	4L+16H





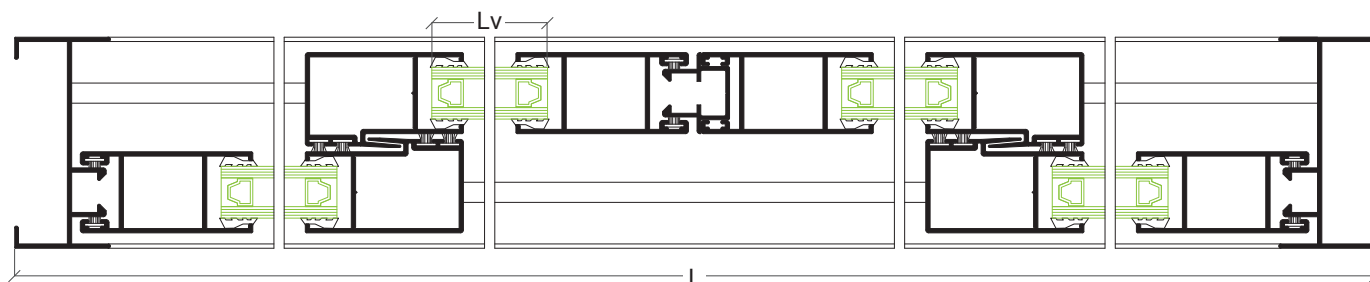

VIDRO • VIDRIO

Hv = H-146 mm	Lv = L/4-78 mm
---------------	----------------



Porta 2 folhas correr • Puerta 2 hojas corredera

PERFIS • PERFILES

DESENHO • DISEÑO	REF.	DESCRIÇÃO • DESCRIPCIÓN	CORTE CORTE	QUANTIDADE CANTIDAD	MEDIDAS • MEDIDA
	CL-05	Padieira • Marco superior		1	L-40 mm
	CL-01	Soleira • Marco inferior		1	L-40 mm
	CL-06	Omreira • Marco lateral		2	H
	CL-10	Móvel carrinho • Hoja de ruedas		4	L/2-12 mm
	CL-20	Móvel lateral • Hoja lateral		2	H-64 mm
	CL-27	Móvel central • Hoja central		2	H-64 mm
	CL-52	Almofada • Zócalo		2	L/2-12 mm
	CL-53	Travessa • Travesaño		2	L/2-12 mm

ACESSÓRIOS E JUNTAS • ACCESORIOS Y JUNTAS







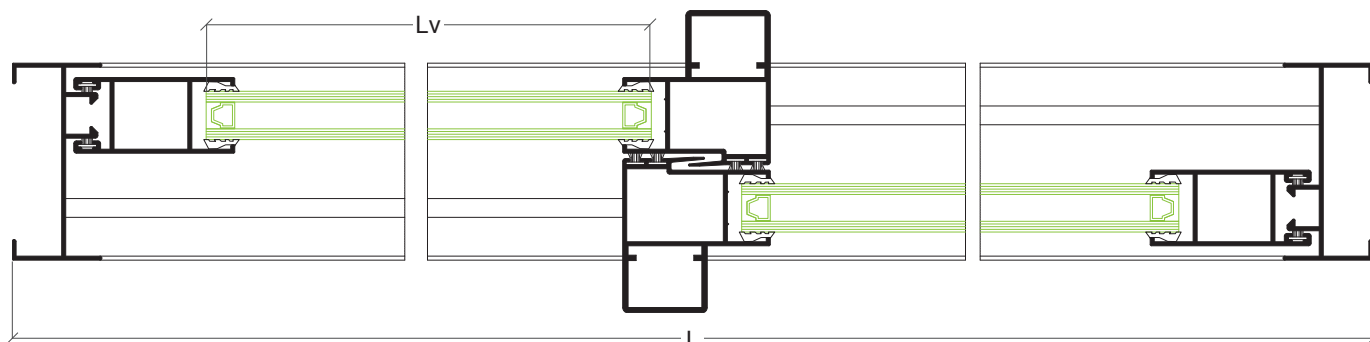
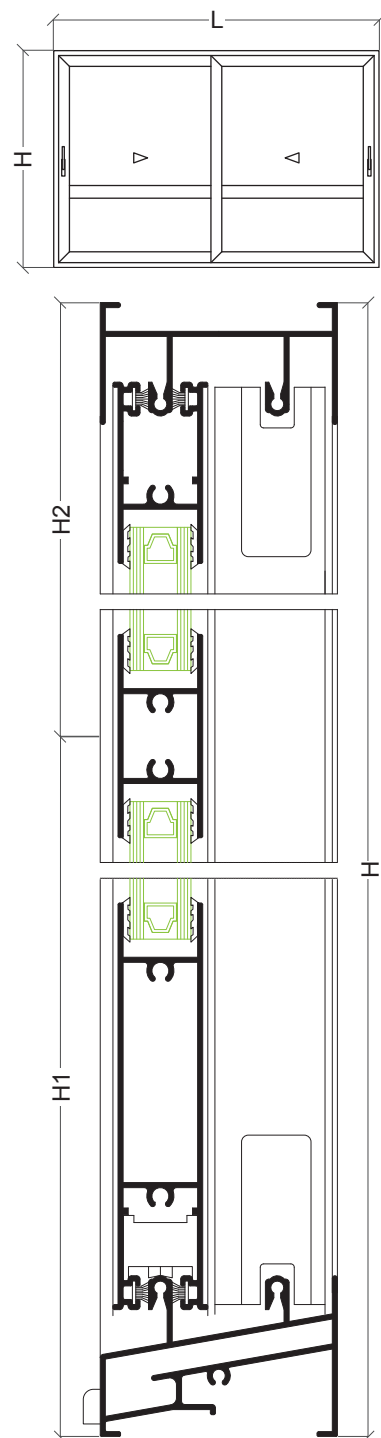

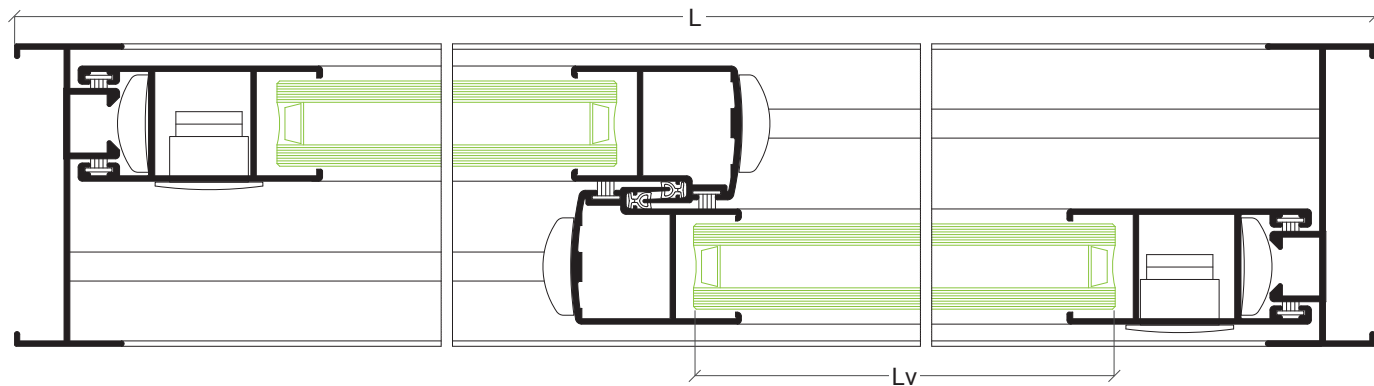
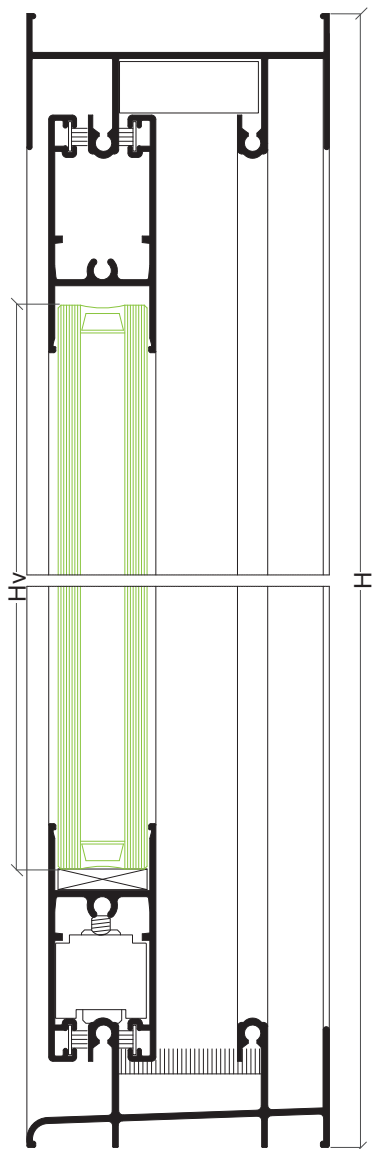
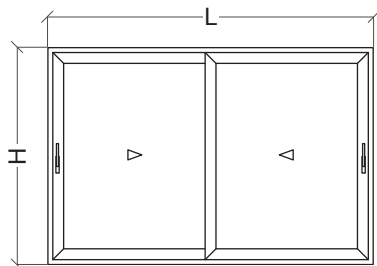

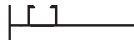

REF.	DESCRIÇÃO • DESCRIPTION	QUANTIDADE CANTIDAD
30 91 50 09/10	Fecho lateral • Cierre lateral	2
30 91 50 27	Rolamentos • Rodamientos	4
30 91 50 30	Corta ventos inferior • Cortavientos inferior	1
30 91 50 40	Corta ventos superior • Cortavientos superior	1
30 91 50 61	Junta estanquidade superior • Junta estanqueidad superior	1
30 91 50 70	Junta estanquidade inferior • Junta estanqueidad inferior	1
30 91 50 80	Tampa guia lateral • Tapón guía lateral	4
30 92 01 00	Goteiras • Vierteaguas	2
30 95 00 40	Pelúcia 7x5.5 mm • Burlete 7x5.5 mm	8L/2
30 95 00 70	Pelúcia 7x3.5 mm (lateral) • Burlete 7x3.5 mm (lateral)	4H
30 95 00 80	Pelúcia 7x5 mm (central) • Burlete 7x5 mm (central)	4H
---	Junta para vidro • Junta para vidrio	6L+8H

VIDRO • VIDRIO

Hv = H2-85 mm	Lv = L/2-89 mm
Hv = H1-166 mm	Lv = L/2-89 mm



Janela 2 folhas correr • Ventana 2 hojas corredera

PERFIS • PERFIS

DESENHO • DISEÑO	REF.	DESCRIÇÃO • DESCRIPCIÓN	CORTE CORTE	QUANTIDADE CANTIDAD	MEDIDAS • MEDIDA
	CL-05	Padieira • Marco superior		1	L-28 mm
	CL-42	Soleira • Marco inferior		1	L-28 mm
	CL-43	Ombreira • Marco lateral		2	H
	CL-47	Móvel carrinho • Hoja de ruedas		4	L/2-16 mm
	CL-44	Móvel lateral • Hoja lateral		2	H-43.5 mm
	CL-45	Móvel central • Hoja central		2	H-43.5 mm





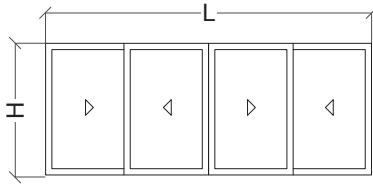

ACESSÓRIOS E JUNTAS • ACCESORIOS Y JUNTAS

REF.	DESCRIÇÃO • DESCRIPTION	QUANTIDADE CANTIDAD
30 91 50 09/10	Fecho lateral • Cierre lateral	2
30 91 50 21	Rolamentos simples • Rodamientos simples	4
30 91 50 31	Corta ventos inferior • Cortavientos inferior	1
30 91 50 40	Corta ventos superior • Cortavientos superior	1
30 91 50 61	Junta estanquidade superior • Junta estanqueidad superior	1
30 91 50 71	Junta estanquidade inferior • Junta estanqueidad inferior	1
30 91 50 81	Jogo guias lateral • Juego guías lateral	8
30 95 00 40	Pelúcia 7x5.5 mm • Burlete 7x5.5 mm	4L+2H
30 95 00 70	Pelúcia 7x3.5 mm (lateral) • Burlete 7x3.5 mm (lateral)	4H
30 91 50 86	Junta central • Junta central	2H
---	Junta para vidro • Junta para vidrio	4L+8H

VIDRO • VIDRIO

Hv = H-132 mm	Lv = L/2-73 mm
---------------	----------------

Janela 4 folhas correr • Ventana 4 hojas corredera

PERFIS • PERFIS

DESENHO • DISEÑO	REF.	DESCRIÇÃO • DESCRIPCIÓN	CORTE CORTE	QUANTIDADE CANTIDAD	MEDIDAS • MEDIDA
	CL-05	Padieira • Marco superior		1	L-28 mm
	CL-42	Soleira • Marco inferior		1	L-28 mm
	CL-43	Ombreira • Marco lateral		2	H
	CL-47	Móvel carrinho • Hoja de ruedas		8	L/4-9 mm
	CL-44	Móvel lateral • Hoja lateral		4	H-43.5 mm
	CL-45	Móvel central • Hoja central		4	H-43.5 mm
	CL-28	União 3/4F • Unión 3/4H		1	H-43.5 mm

ACESSÓRIOS E JUNTAS • ACCESORIOS Y JUNTAS

REF.	DESCRIÇÃO • DESCRIPTION	QUANTIDADE CANTIDAD
30 91 50 09/10	Fecho lateral • Cierre lateral	3
30 91 50 21	Rolamentos simples • Rodamientos simples	8
30 91 50 31	Corta ventos inferior • Cortavientos inferior	3
30 91 50 40	Corta ventos superior • Cortavientos superior	3
30 91 50 61	Junta estanquidade superior • Junta estanqueidad superior	1
30 91 50 71	Junta estanquidade inferior • Junta estanqueidad inferior	1
30 91 50 81	Jogo guias lateral • Juego guías lateral	14
30 95 00 40	Pelúcia 7x5.5 mm • Burlete 7x5.5 mm	4L+4H
30 95 00 70	Pelúcia 7x3.5 mm • Burlete 7x3.5 mm	6H
30 91 50 86	Junta central • Junta central	4H
---	Junta para vidro • Junta para vidrio	4L+16H







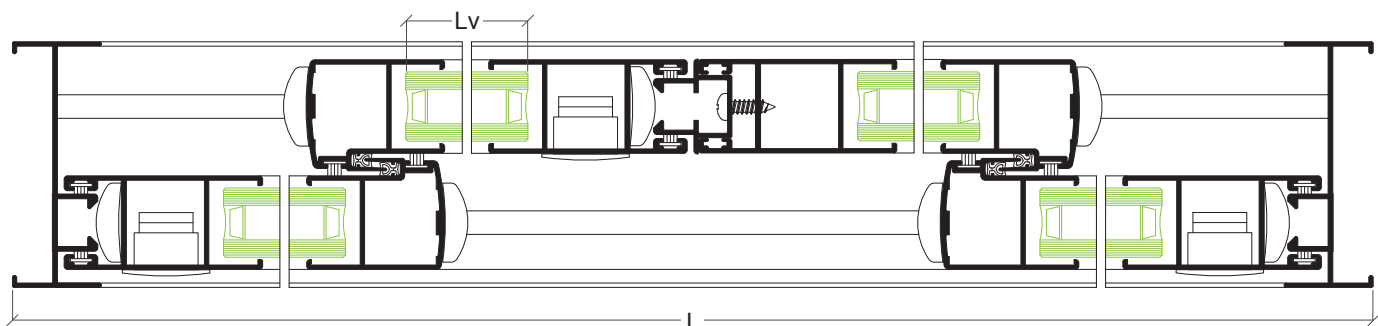
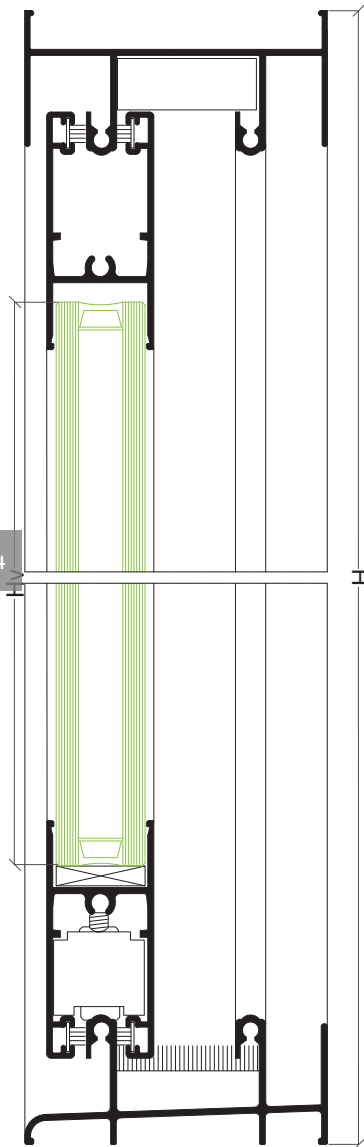





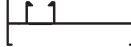

VIDRO • VIDRIO

Hv = H-132 mm	Lv = L/4-66 mm
---------------	----------------

114



Porta 2 folhas correr • Puerta 2 hojas corredera
PERFIS • PERFIS

DESENHO • DESEÑO	REF.	DESCRIÇÃO • DESCRIPCIÓN	CORTE CORTE	QUANTIDADE CANTIDAD	MEDIDAS • MEDIDA
	CL-05	Padieira • Marco superior		1	L-28 mm
	CL-42	Soleira • Marco inferior		1	L-28 mm
	CL-43	Ombreira • Marco lateral		2	H
	CL-47	Móvel carrinho • Hoja de ruedas		2	L/2-9 mm
	CL-44	Móvel lateral • Hoja lateral		2	H-43.5 mm
	CL-48	Móvel central • Hoja central		2	H-43.5 mm
	CL-49	Travessa • Travesaño		2	L/2-9 mm

ACESSÓRIOS E JUNTAS • ACCESORIOS Y JUNTAS

REF.	DESCRIÇÃO • DESCRIPTION	QUANTIDADE CANTIDAD
30 91 50 09/10	Fecho lateral • Cierre lateral	2
30 91 50 21	Rolamentos simples • Rodamientos simples	4
30 91 50 23	Rolamentos suplementares • Rodamientos suplementarios	4
30 91 50 31	Corta ventos inferior • Cortavientos inferior	1
30 91 50 40	Corta ventos inferior • Cortavientos superior	1
30 91 50 61	Junta estanquidade superior • Junta estanqueidad superior	1
30 91 50 71	Junta estanquidade inferior • Junta estanqueidad inferior	1
30 91 50 81	Jogo guias lateral • Juego guias lateral	8
30 95 00 40	Pelúcia 7x5.5 mm • Burlete 7x5.5 mm	4L+2H
30 95 00 70	Pelúcia 7x3.5 mm (lateral) • Burlete 7x3.5 mm (lateral)	4H
30 91 50 86	Junta central • Junta central	2H
----	Junta para vidro • Junta para vidrio	4L+8H

VIDRO • VIDRIO



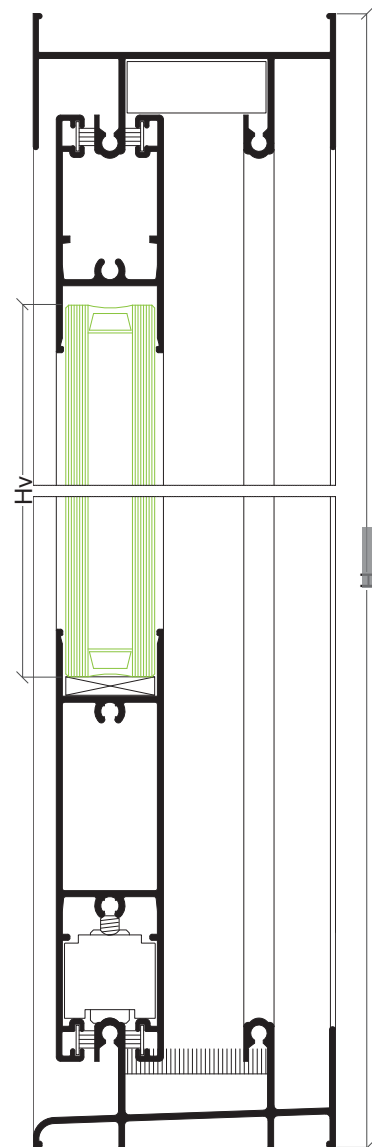
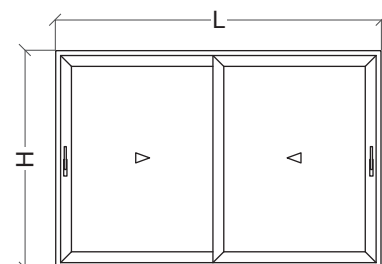



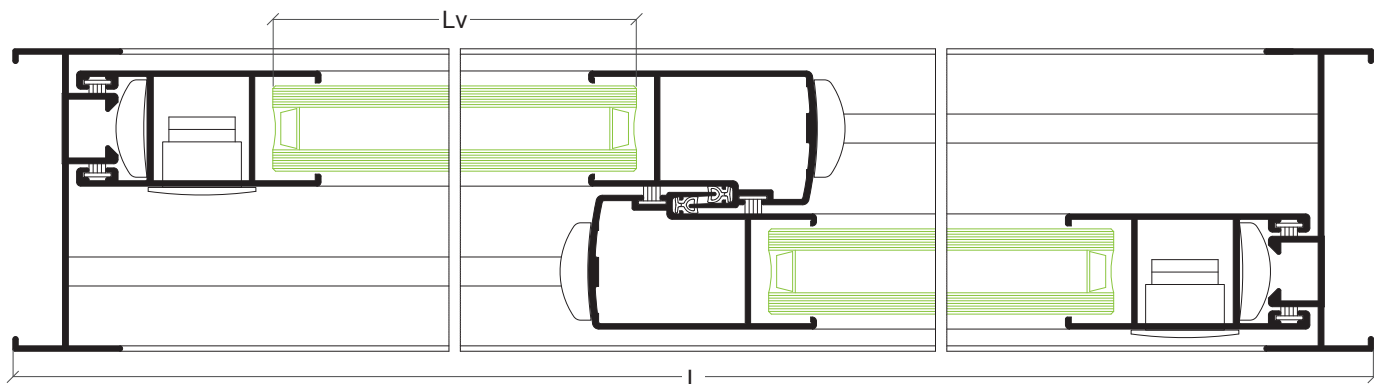



Hv = H-177 mm	Lv = L/2-80 mm
---------------	----------------

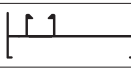

115



Porta 4 folhas correr • Puerta 4 hojas corredera
PERFIS • PERFIS

DESENHO • DISEÑO	REF.	DESCRIÇÃO • DESCRIPCIÓN	CORTE CORTE	QUANTIDADE CANTIDAD	MEDIDAS • MEDIDA
	CL-05	Padieira • Marco superior		1	L-28 mm
	CL-42	Soleira • Marco inferior		1	L-28 mm
	CL-43	Ombreira • Marco lateral		2	H
	CL-47	Móvel carrinho • Hoja de ruedas		4	L/4-2 mm
	CL-44	Móvel lateral • Hoja lateral		4	H-43.5 mm
	CL-48	Móvel central • Hoja central		4	H-43.5 mm
	CL-49	Travessa • Travesaño		4	L/4-2 mm
	CL-28	União 3/4F • Unión 3/4H		1	H-43.5 mm

ACESSÓRIOS E JUNTAS • ACCESORIOS Y JUNTAS

REF.	DESCRIÇÃO • DESCRIPTION	QUANTIDADE CANTIDAD
30 91 50 09/10	Fecho lateral • Cierre lateral	3
30 91 50 21	Rolamentos simples • Rodamientos simples	8
30 91 50 23	Rolamentos suplementares • Rodamientos suplementarios	8
30 91 50 31	Corta ventos inferior • Cortavientos inferior	3
30 91 50 40	Corta ventos superior • Cortavientos superior	3
30 91 50 61	Junta estanquidade superior • Junta estanqueidad superior	1
30 91 50 71	Junta estanquidade inferior • Junta estanqueidad inferior	1
30 91 50 81	Jogo guias lateral • Juego guías lateral	14
30 95 00 40	Pelúcia 7x5.5 mm • Burlete 7x5.5 mm	4L+4H
30 95 00 70	Pelúcia 7x3.5 mm • Burlete 7x3.5 mm	6H
30 91 50 86	Junta central • Junta central	4H
----	Junta para vidro • Junta para vidrio	4L+16H

VIDRO • VIDRIO

Hv = H-177 mm	Lv = L/4-73 mm
---------------	----------------

